

TN745D - Feller Buncher

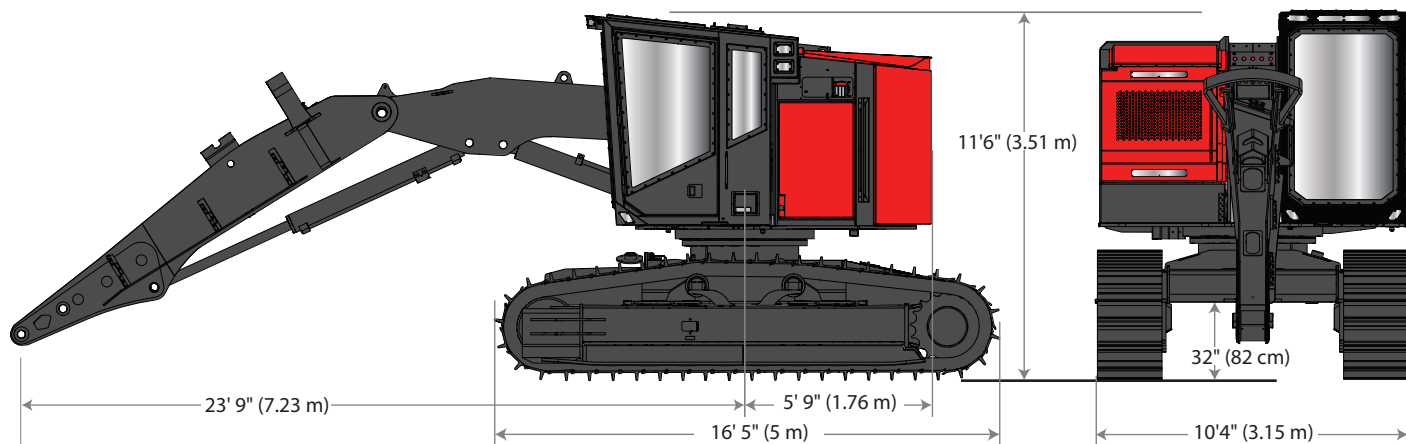

TimberPro Inc reserves the right to change specifications without notice or obligation. Product illustrations may be equipped with non-standard equipment.

Engine:

Cummins L9 Series Engine
Single Module DOC/DPF/SCR
Max HP - 338 hp (252 kw)
1126 lb-ft (1526 N-m) @ 1400 RPM
Fuel Tank - 100 gallons (378 Liters)

Cooling:

Fan - 42" Hydraulic Driven,
Variable Speed with Auto Reversing Feature

Control System:

IQAN MD4 HD control system

- 10" touch screen
- Engine Management
- Troubleshooting Diagnostics
- Over and Under Temperature Protection

Electrical System:

Alternator - 100 amp 24 Volt
Batteries - 2 /12 Volt @ 1000 CCA
Work Lights - LED High Intensity Lighting

Serviceability:

Rear Gull Wing Canopy Opens to Access to
Engine and Hydraulic Components
Side Access Service Doors
Retractable step for operators cabin
Hydraulic Tank Vacuum System

Hydraulic System:

Implement Pump - 145cc Variable Disp Piston
Aux Saw Pump - Dedicated 60cc Piston
Swing Pump - Dedicated 90cc Hydrostatic
Drive Pumps - Dedicated 90cc Dual Hydrostatic
Charge Pump - Gear Pump 50cc
Valve - Parker L90LS / K220
Electric hyd oil fill pump

Filtration System:

Charge Filter Non By-Pass 6 micron
Return Filters w/By-Pass 10 micron
Case Drain Filter w/By-Pass 10 micron

Upper Turntable Swing:

Gearbox - Rexroth GFB17 (45.66:1)
Swing Motor - Rexroth Bent Axis - 56cc
Hydrostatic energy recovery system
Swing Torque: 57,800 ft-lbs (78,366 N-m)
Continuous Rotation Swing

Safety:

ANSUL LVS 15 Gallon Liquid Agent Fire
Suppression System

Machine Weight:

Base Machine: 61,200 lbs (27,560 kg)

(approximate "woods ready" operating weight without attachment)

Boom Performance:

Maximum Reach (Pin Point) - 23.9ft (7.2 m)
Lift Capacity @ Max Reach - 9,220 lbs (4,182 kg)
Lift Capacity @ 15' (4.6 m) - 17,340 lbs (7,865 kg)

Undercarriage:

Caterpillar 330 (D7) Frame
Track Pads - 48 - D7 HD (600, 700 or 800mm)
Final Drives - Lohmann GFT-80
Drive Motors - Rexroth 2-speed Auto Shift
Tractive Effort - 80,066 lbs (356 kN)
Travel Speed - 0 to 3.5 mph

Operators Cabin:

ROPS/FOPS/OPS Certified cabin
1.25" Front Window
Digital Climate Control System
Three Emergency Escape routes
Fresh air filtered & Pressurized cabin
AM/FM/WB - Bluetooth/Handsfree - USB
Deluxe Seat - Air ride, Heat & Lumbar
Rear View Camera System

www.timberpro.com